



# Russian software industry today offers new opportunities for strategic partnerships with Finland

November 10, 2009

Helsinki

Arcady Khotin

Board Member of RUSOFT Association

[www.russoft.org](http://www.russoft.org)

# *RUSSOFT (www.russoft.org)*

- **RUSSOFT** is the major Association of 60+ leading software development companies from Russia (also some from Belarus) with more than 23000 software engineers, \$800 M of export turnover
- Part of the Russian Information and Computer Industry Association (APKIT).
- Close partnership with the Russian Association of Electronics' manufacturers
- Leadership in implementing PM and QA (CMMI/ISO) standards in the Industry
- Organizer of marketing and PR activities in Russia and abroad (RUSSOFT Forum, Mobile Software Forum, SECR, IT-Seasons, National Pavilions at CeBIT, ...)
- Active lobbyist of IT interests in the Russian Government (IT-parks and Free Economic Zones, Export Promotion Agency, Law on better taxation, less administrative barriers, more effective educational system, etc.)



# *International Cooperation.*

## *Agreements with:*

- BITKOM (Germany)
- Massachusetts Software Council (US)
- Connecticut Technology Council (US)
- Software Association of New Hampshire (US)
- Vermont Chamber of Commerce (USA)
- US-Russia Chamber of Commerce of New England (USA)
- Israel Association of Electronics and Information Industries – IAEII
- Kansai Information Systems Association (Japan)
- Forum Nokia leads Committee on Mobile Software inside of RUSOFT
- Nokia Research Centre in FRUCT project
- Are Finnish ICT people interested to connect with RusSoft? Talk to me!



# Russian IT-market growth, 2007/2008 (\$M)

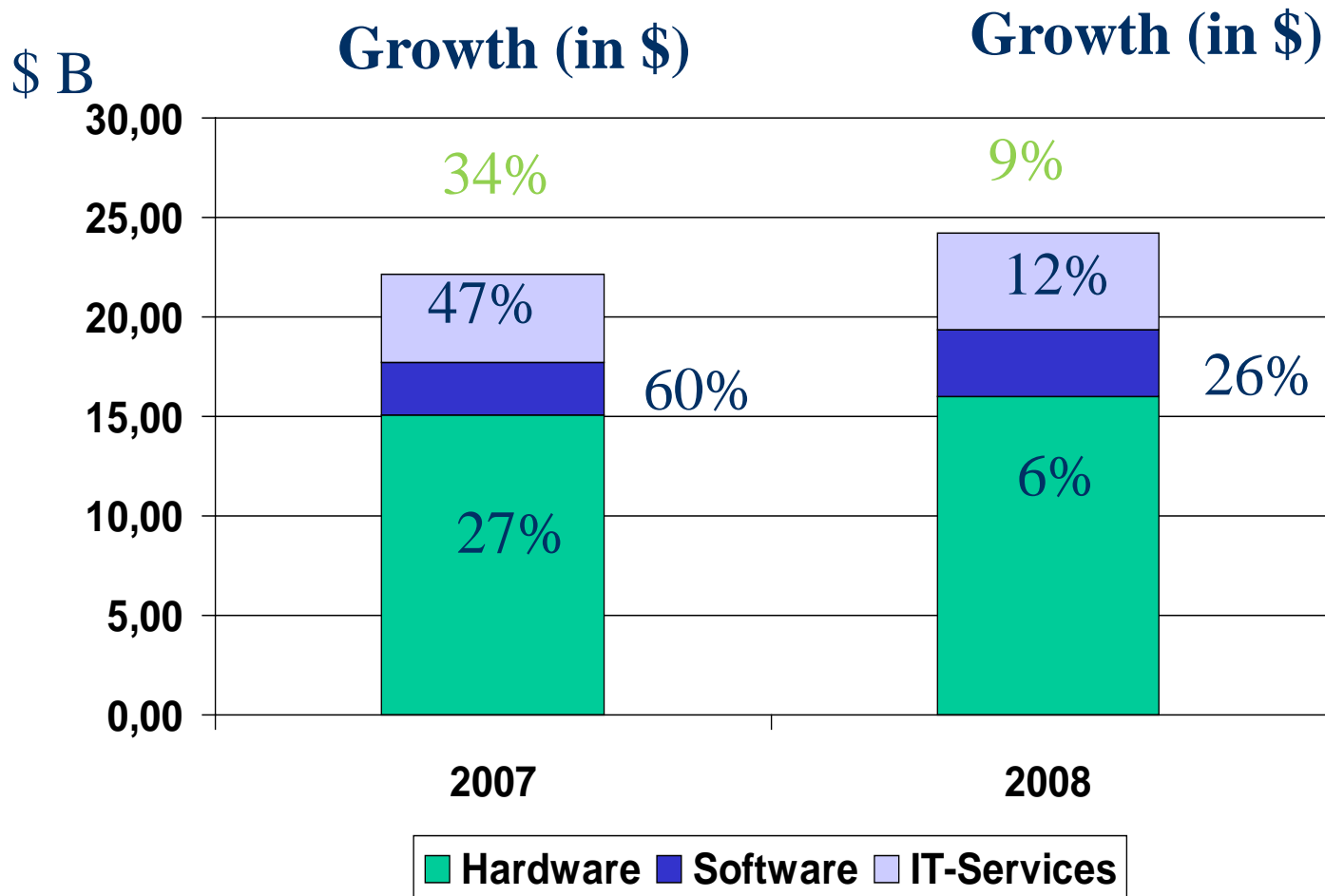

Source: IDC, 2009

# Major IT-market growth factor in Russia ...

IT-market and dynamics of petrol prices, 1994-2008

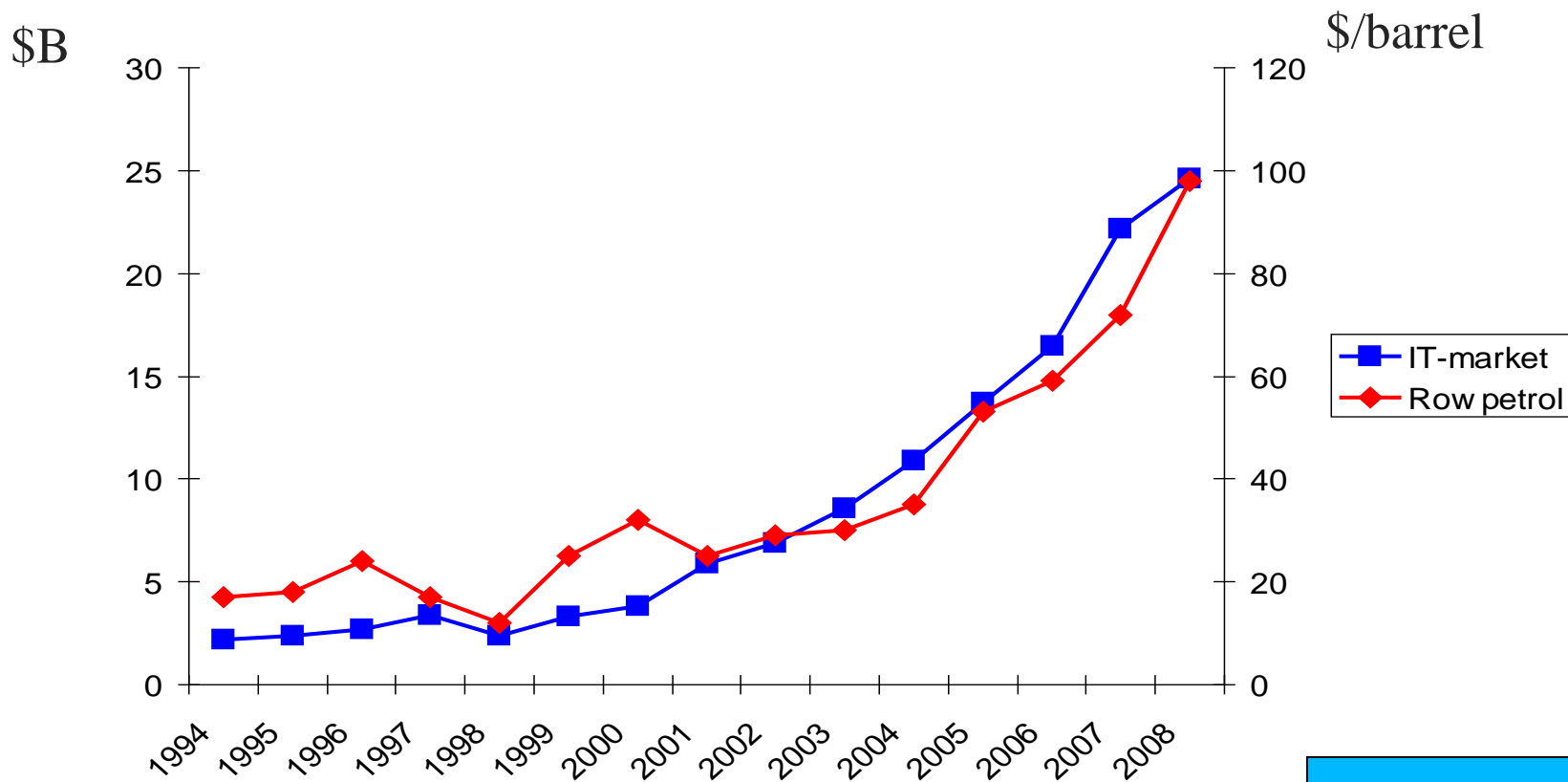

Source: Energy Information Administration

Slide is provided by  
IDC experts

# Russian IT-market growth, 2008/2009 (RUR)

RUR, B

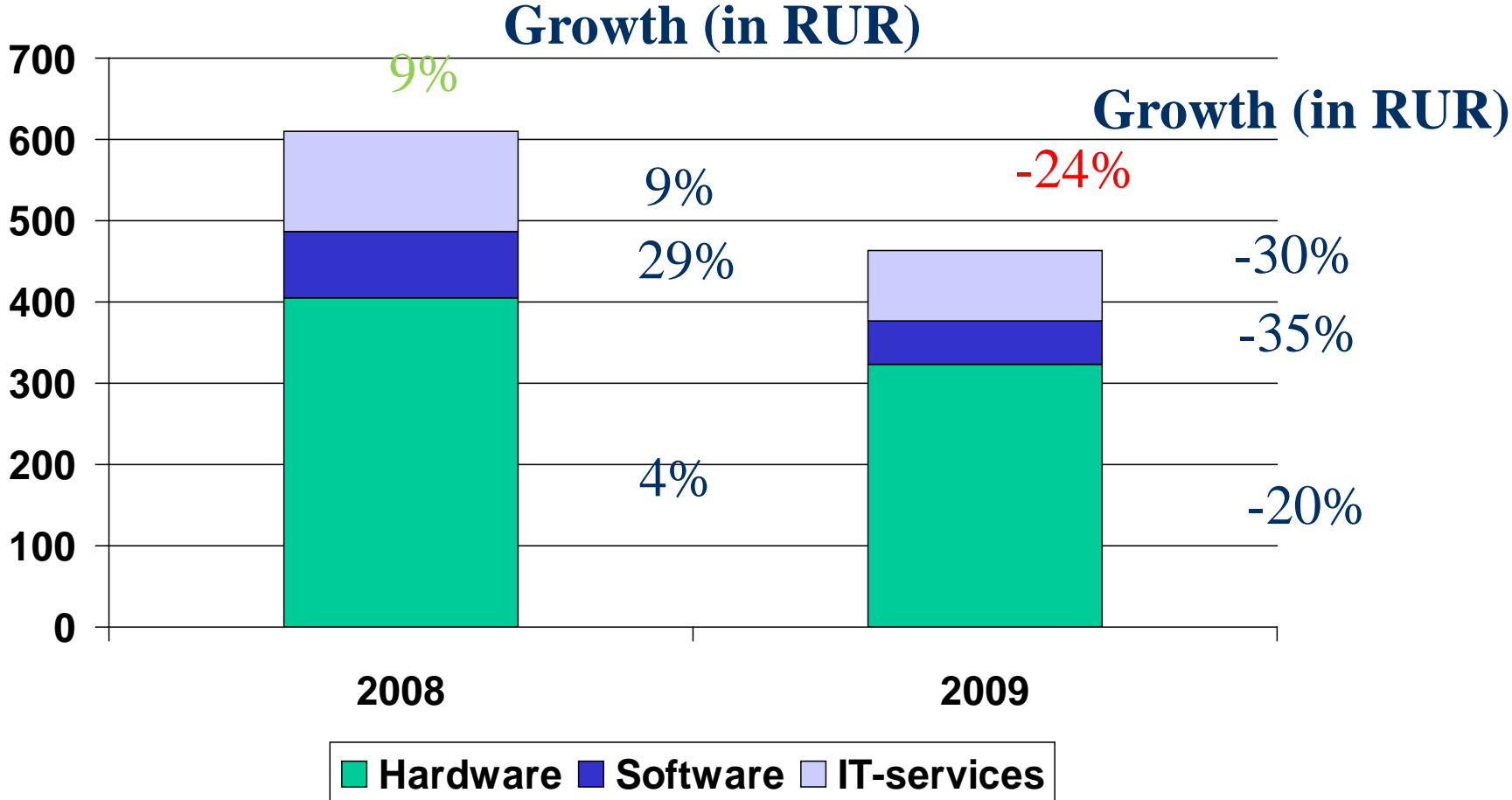

Source: IDC, 2009

# Table of Russian ICT market size, data from Market Visio



| Year | Market Size (USD) |
|------|-------------------|
| 2015 | 10.5              |
| 2016 | 11.2              |
| 2017 | 12.1              |
| 2018 | 13.0              |
| 2019 | 14.0              |
| 2020 | 15.0              |
| 2021 | 16.0              |
| 2022 | 17.0              |
| 2023 | 18.0              |
| 2024 | 19.0              |
| 2025 | 20.0              |
| 2026 | 21.0              |
| 2027 | 22.0              |
| 2028 | 23.0              |
| 2029 | 24.0              |
| 2030 | 25.0              |



RUS®SOFT

**Объем экспорта программного обеспечения и услуг по его разработке в  
2002-2009 годах, \$ млн.**

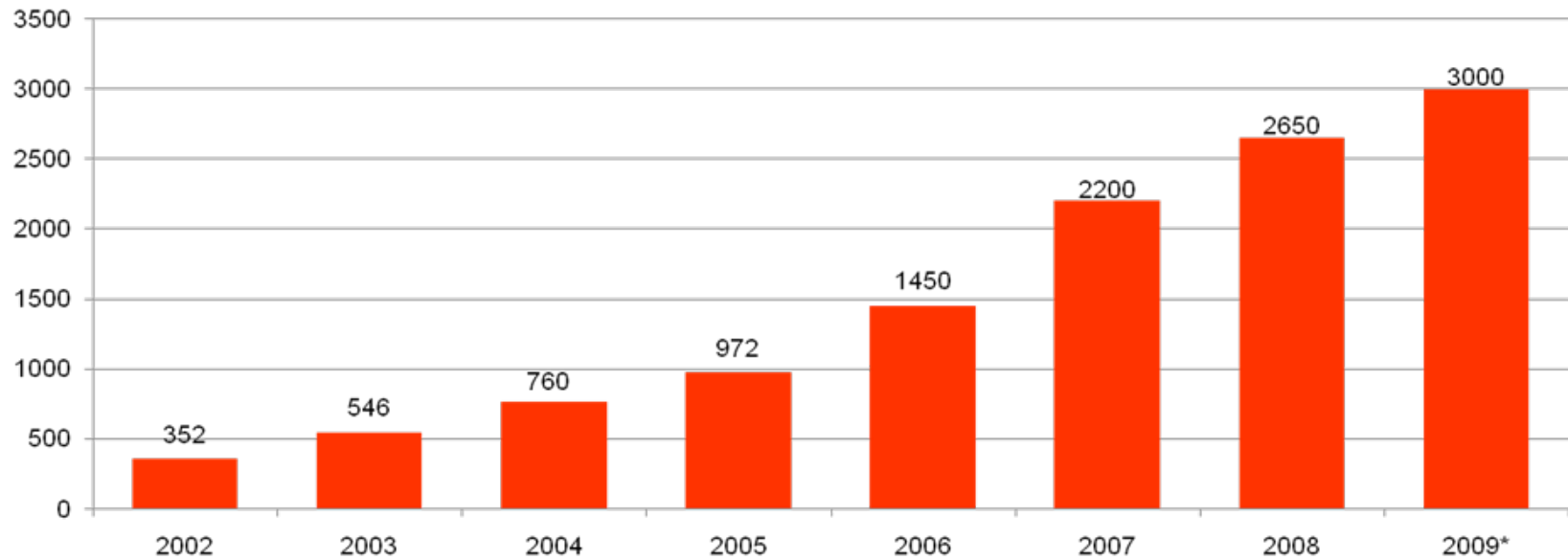

# NeoIT reports on January 07, 2007

- “...Russia would emerge as a strong contender in the IT outsourcing market with an expected growth of 40-45 per cent in 2007. It is currently the third largest IT outsourcing supply market, behind India and China”
- “...Russian IT companies specialize in high-end software and embedded software product development, which acts as a differentiator from lower-priced offerings from Indian companies”

# “Russian expertise in application development is considered the best in the World”

- “Russian software companies are renown for their effective delivery of services and their ability to perform non-standard tasks”
- “They opt for (science) intensive projects and deliver high quality work”
- “Russian software engineers and researchers are highly qualified with excellent programming skills and are competent in developing complex projects”
- Frost&Sullivan, Report 4F84-90

# Gartner's view on Russian ICT and software services

## International companies:

- Hewlett-Packard (approx. IT services revenue 60-70 mEUR in 2008)
- IBM (approx. IT services revenue 40-50 mEUR in 2008)
- Siemens BS (approx. IT services revenue 80-90 mEUR in 2008) – Fujitsu (ICL-KMECS)

source:

Some well-known software developers in Russia (in random order):

- **1C (1S)**
- **Luxoft (member of IBS Group)**
- **Reksoft -St.Petersburg**
- **DataArt -St.Petersburg**
- **EPAM Systems -St.Petersburg**
- **Digital Design -St.Petersburg**
- **Kaspersky Labs**
- **Jet Infosystems**
- **Cognitive Technologies**
- **Diasoft**
- **Arcadia Inc. -St.Petersburg**
- **R-Style Softlab (member of R-Style Group)**

# Finnish ICT and non-ICT pioneers with offices in St.Petersburg

- NOKIA
- Tieto
- Endero
- Digia
- Elisa
- TekLabs
- Konsu Accountor Group
- Finnish Consulting Group
- Technopolis (TEKES, FinVera, VTT)
- Yit, Nokian Tires, CapMan, Fintra, etc.

# Recent Finnish- Russian ICT events in 2009

- Kouvola, Oct 8-9, KITES / Digibusiness meeting with Finnish and Russian companies
- SonomaTalo Oct.22, PrismaConsulting and Digital Design
- SonomaTalo Nov.10 PrismaConsulting and Arcadia,Inc
- November 12 IT-sopimukset ja Venäjän ohjelmistoliiketoiminta (TTL)
- More Finnish-Russian seminars are planned in 2010

# Case studies about Russian software companies from LUT

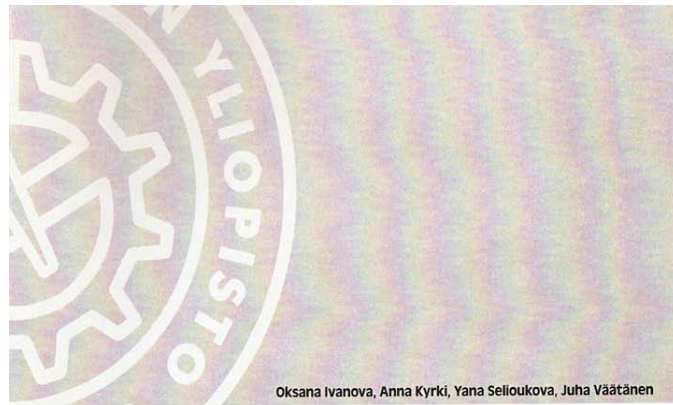

Oksana Ivanova, Anna Kyrki, Yana Selloukova, Juha Väättänen

CASE STUDY ON SOFTWARE DEVELOPMENT  
COMPANY – OPPORTUNITIES AND CHALLENGES  
OF RUSSIAN HIGH-TECH START-UP



LAPPEENRANTA UNIVERSITY OF TECHNOLOGY  
NORTHERN DIMENSION RESEARCH CENTRE

PUBLICATION 15

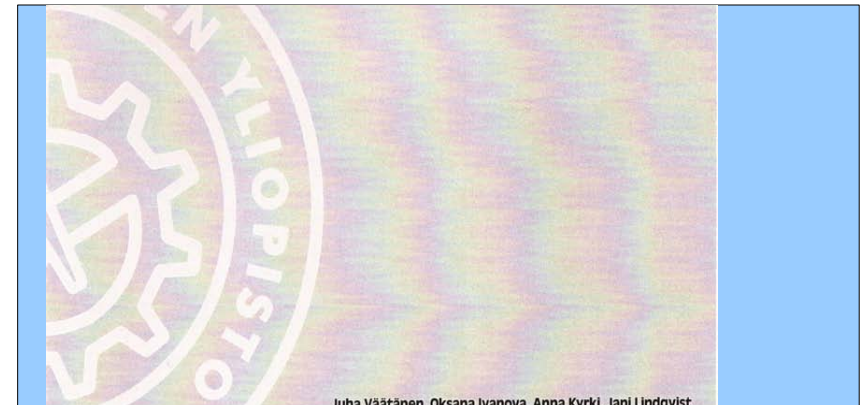

Juha Väättänen, Oksana Ivanova, Anna Kyrki, Jani Lindqvist

CASE STUDY ON RUSSIAN OFFSHORE  
SOFTWARE DEVELOPMENT – STRATEGY IN THE MAKING



LAPPEENRANTA UNIVERSITY OF TECHNOLOGY  
NORTHERN DIMENSION RESEARCH CENTRE

PUBLICATION 12

Not only case studies but entire PhD dissertation was done on outsourcing to Russia topic.

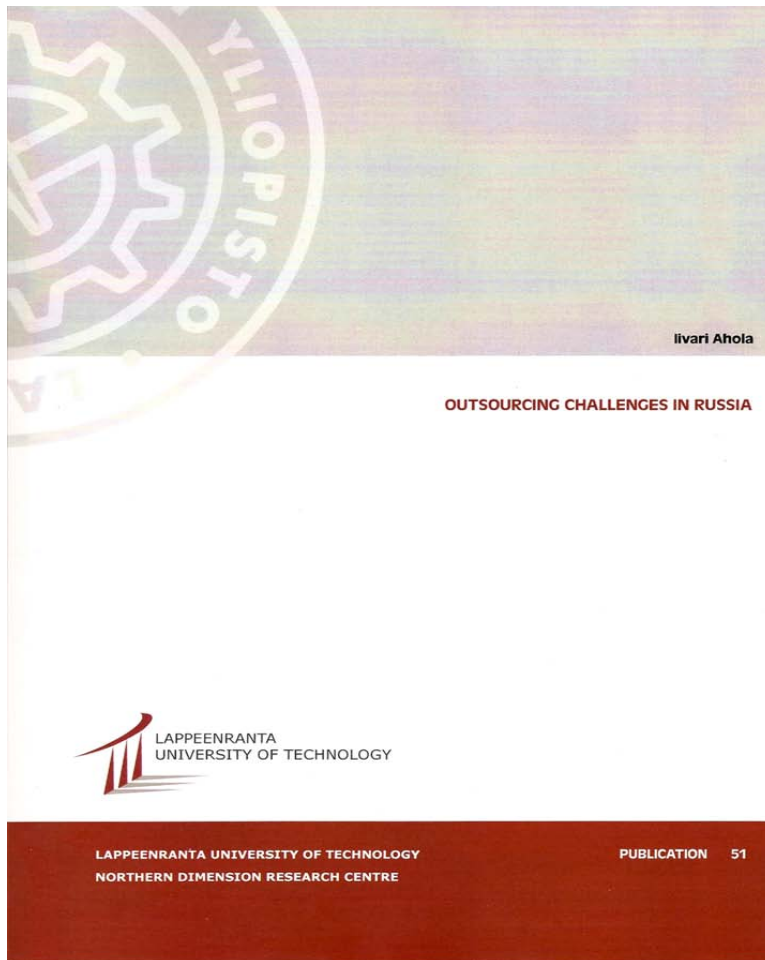

# Two public sources of information available to use for home reading



## IT market and Suppliers in Russia

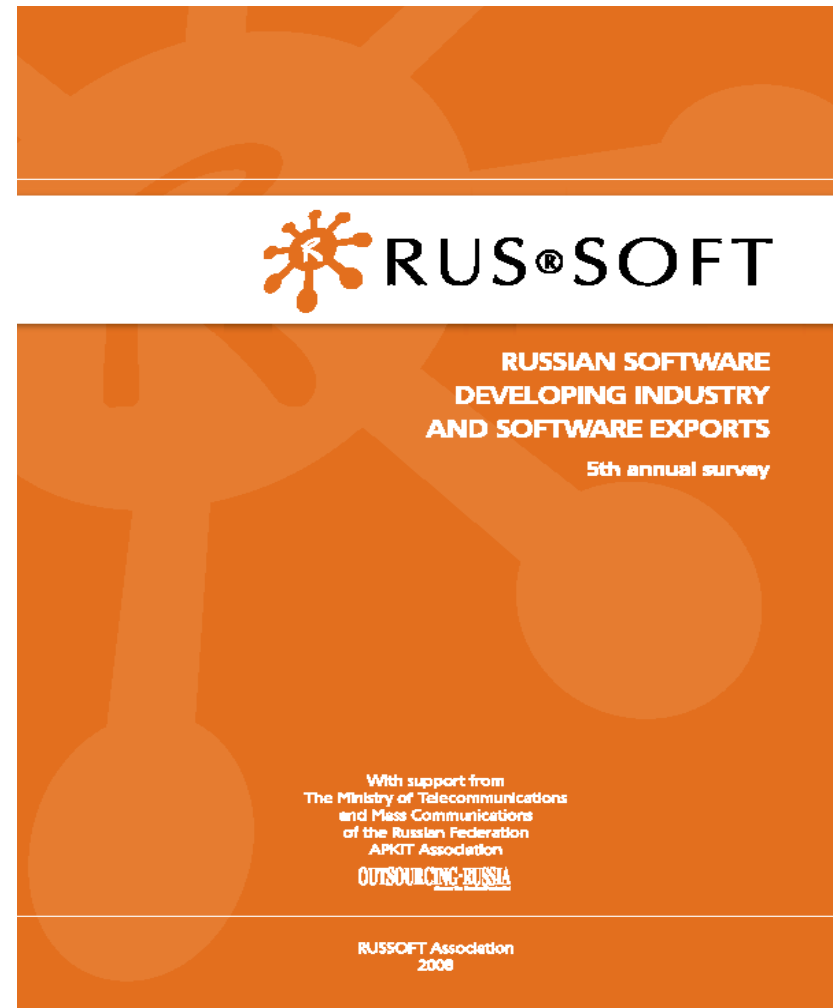
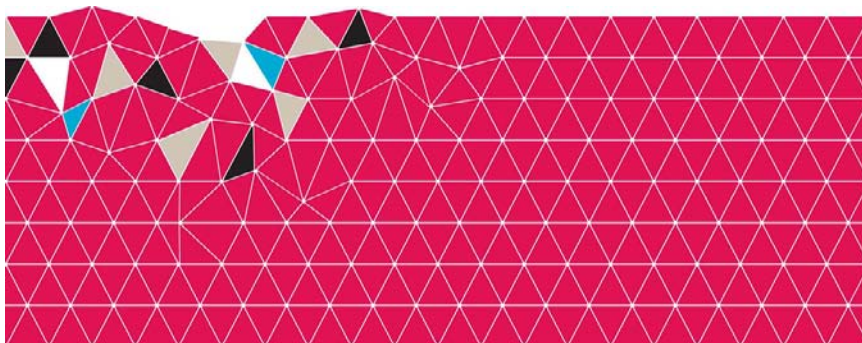

# Russian IT people and Finland?



- **What is known:** High standards of life, great fishing and winter sports, Koskenkorva and NOKIA.
- **What is not known:** Finnish, TEKES, FinPro, FinNode, FinVera, ICT, business rules.

# Finnish IT people and Russia?

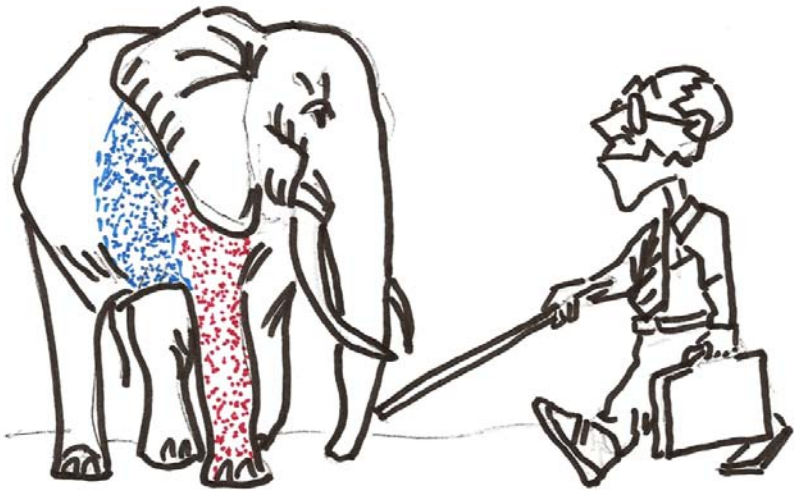

- **What is known:**  
Vodka, mutual history, Putin, oil, high tariffs on wood export, my grandma's house
- **What is to known yet:** RusSoft, Russian software, nearshoring advantages

# Conclusions



- Within past 10 years Russia became World #2-3 in terms of HighTech off-shore IT-services.
- Russian High Education brings new generations of ever best engineers to the Global market every Year. They do not leave the country. Instead they produce new software and services, create new businesses.
- Russian Software Development Industry is ready to fit Finish ICT to forge a worth and sound synergetic market force

# Thank You!

Please visit our pages at

<http://www.russoft.org>

Feel free to contact me at

khotin@gmail.com

# Russian Software producers. Success stories



**ABBY**

[www.abby.com](http://www.abby.com)

## Successful Projects in India

- District Institute of Educational Training (DIETCET) (Andhra Pradesh)
- State Board of Technical Education and Training (SBTET) (Andhra Pradesh)
- Chennai Anna University
- Deemed University, Padmashree Dr. D. Y. Patil Vidyapeeth
- National Institute for Information Technology (NIIT), Delhi
- Cochin University of Science and Technology
- Pondicherry Engineering College
- Bangalore Common Entrance Test Cell
- All India Institute of Medical Sciences (AIIMS)





# Kaspersky Labs

- Among 10 World leaders in anti-virus software vendors (IDC)
- Over 1000 people in the stuff
- #1 retail anti-virus software in Germany
- 140% growth rate and over \$200 Mio of turnover in 2007



# Corporate Overview

December 2008



# Spb Software



[www.spbsoftwarehouse.com](http://www.spbsoftwarehouse.com)

[partners@softspb.com](mailto:partners@softspb.com)

# SpbSoftware House - Corporate Fact Sheet

- Founded in 1999, focus on mobile software since 2001
- 80 full time employees, R&D and design sites in Russia and Thailand, presence in Hong Kong, Taiwan, USA
- OEM and Carrier partners include: ASUS, E-TEN, Fujitsu Siemens Computers, Gigabyte, HTC, O2, Optimus, Palm, Pharos, Samsung, SingTel, Sky Link, Sony Ericsson, Swisscom, Toshiba, T-Mobile, and VimpelCom.
- Awards and Recognition: 33 "Best Software" awards from Smartphone & Pocket PC magazine, dozens more awards from Handster.com, Handango, Shareware Industry Awards, Microsoft, 5 out of 10 world's best-selling WM Professional software titles are Spb products (First Half 2008 Handango Yardstick)
- **Offer to OEMs\ODMs and carriers: Device custom online services and in-ROM applications**
- **5,000,000 licenses shipped, worldwide**



RUS-SOFT  
NATIONAL  
SOFTWARE  
DEVELOPMENT  
ASSOCIATION

# SPIRIT is Voice and Video Engine Expert

## SPIRIT is voice and video experience

- Voice, video, audio, telecom software products

- 16 successful years in international software biz

- 100M+ embedded voice channels powered



- 200+ first-class customers, largest OEMs

- ARM preferred audio and voice software partner
- Local representatives in 12 countries, including Taiwan

- Strategic partnership and joint product with TI

- RMI partner for voice&video on MIPS-based RMI processors

- Tensilica strategic partner for audio

## Selected customer testimonials:



*It was a challenging solution enabling experience to us, and we made it!*

Lotus Chen, Vice President, HTC Corp.



*SPIRIT - the voice&video engine provider with the best offering and reputation.*

Larry Sun, General Manager, Importek



*SPIRIT again has demonstrated its ability to deliver the highest quality voice and video over IP experience.*

Shyi-Ching Lin, Education Platform Project Leader, NCHC



# SPIRIT + Taiwan: Cooperation Areas

Embedded voice&video software for chipmakers to create application-ready chip

- Platform optimization
- Low resource consumption
- Support for a wide range of DSP and RISC platforms

Voice&Video Software Engine and automatic AEC for mobile OEMs

- High quality voice and video thanks to design adaptation
- BOM at minimum with single low MIPS processor
- Automated high-quality AEC configuration within 24 hours

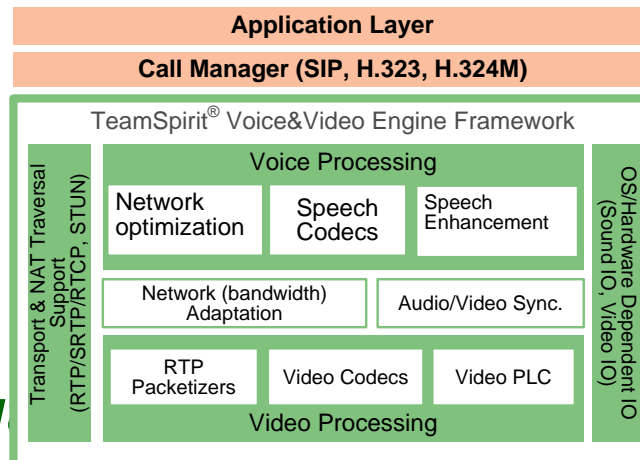

Complete HD-enabled Voice&Video Engine for desktop VVoIP phone, VoIP gateway and IP-TV STB OEMs

- Hardware acceleration for better video
- Proprietary engine framework to secure voice and video quality
- Network optimization for reliable performance

Voice&Video Conferencing Engine for online games

- In-browser voice chat to give the online game an additional edge
- Various conferencing scenarios
- Best server and bandwidth use efficiency with the highest voice quality

# SPIRIT + Taiwan: Cooperation Areas

High-performance GPS+GLONASS baseband software DuoStar for chipmakers to create baseband chip or hardware receiver design

- Accuracy: 5 m autonomous, 1 m differential
- Start time: reacquisition 1 s, hot start 4 s, cold start 30 s
- Sensitivity: -140 dBm (autonomous acquisition mode), -150dBm (tracking mode)

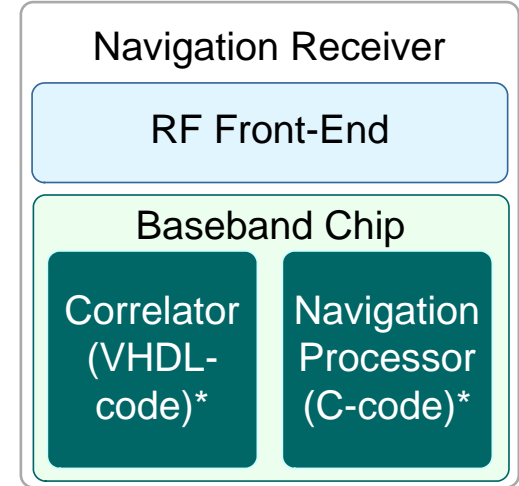

\* SPIRIT GPS+GLONASS Baseband Software

DuoStar is already deployed in several hardware receiver designs:

DuoStar-1000



DuoStar-2000,  
cor.



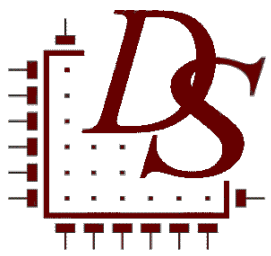

# Navigation ASIC design

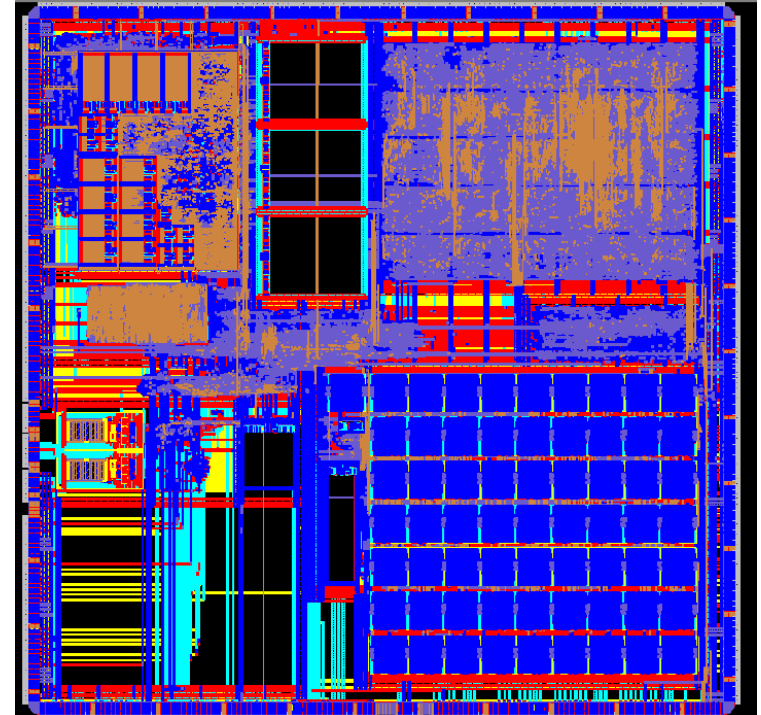
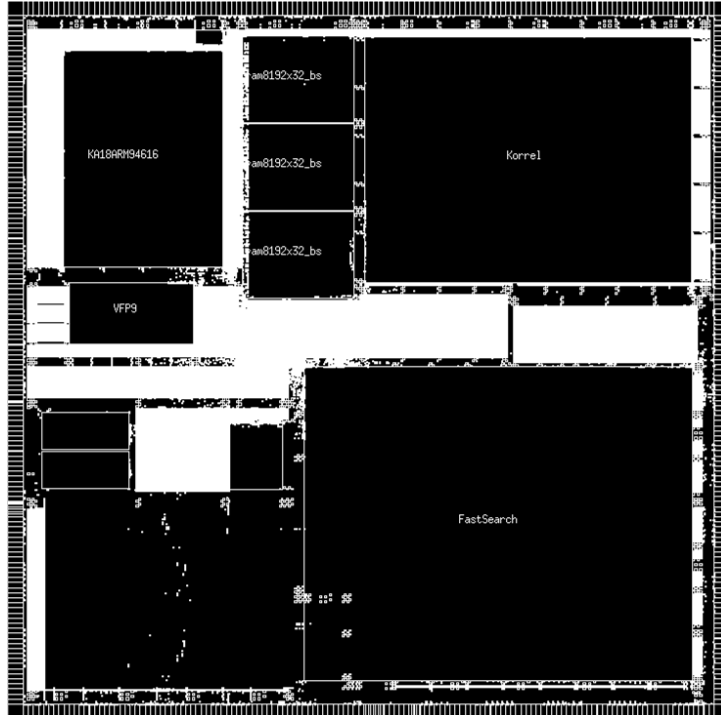

GLONASS/GPS SoC

64 channel, ARM 9, BGA 484

CMOS 0.18 μm

Digital Solutions Ltd

[www.dsol.ru](http://www.dsol.ru)

# WinWap OEM Browser and WinWap MMS Client

Mobile Internet Browsing and Multimedia  
Messaging

SoftAge

Novosibirsk, Russia

[www.winwap.com](http://www.winwap.com)

# Voice Translation and Voice Organisation

SPEEREO

St Petersburg, Russia

[www.speereo.com](http://www.speereo.com)

[www.speereo.vt.com](http://www.speereo.vt.com) (Speereo Voice Translator)

<http://www.personal-secretary.com/index.html> (Speereo Voice Organizer)

First commercial Chinese Voice Integration

# Mobile WiMAX National provider (4G)

YOTA

St Petersburg, Russia

[www.yota.com](http://www.yota.com)